



FSP COOL LOCKERS® EUROPE

Heavy duty modular locker systems

Europe Locker Catalogue 1st Edition



Proudly supplying lockers around the world for over 20 years

FSP COOL LOCKERS®

FSP COOL LOCKERS® have unique advantages over lockers made from traditional materials such as timber and metal. They are designed to last and to keep looking good in all environments. FSP COOL LOCKERS® are easy to clean - simply hose them out.

“The lockers still look new after two years of daily use by high school students. They are in excellent condition. Our students love using them too. They are so quiet to operate and easy to clean”

Simon Bridgeman, Deputy Principal

FSP COOL LOCKERS® Popular Models	4, 5
FSP COOL LOCKERS® Unique Advantages	6
FSP COOL LOCKERS® Installation Gallery	7 - 9
FSP COOL LOCKERS® Modular System	10, 11
FSP COOL LOCKERS® A Series Examples	12, 13
FSP COOL LOCKERS® B Series Examples	14, 15
FSP COOL LOCKERS® C Series Examples	16, 17
FSP COOL LOCKERS® D Series Examples	18, 19
FSP COOL LOCKERS® E Series Examples	20, 21
FSP COOL LOCKERS® Modern Colour Range	22, 23
Accessories	24
Case Study	25
FSP COOL LOCKERS® Combination Options	26, 27
FSP COOL LOCKERS® Mobile Phone Locker	28
FSP COOL LOCKERS® Wardrobe Locker	29
FSP COOL LOCKERS® OL1800 Locker	30
How To Order	31



These popular models of FSP COOL LOCKERS® require no customisation and are all available with shorter lead times for delivery. All our popular models are available in 25 different colours.



A4GRY-4TEA1
Teal 338



A4GRY-2PUR2
Purple 538



A4GRY-1ORA4
Orange 61



B4GRY-2MBE2
Mountain Blue 392



C4GRY-4LGN1
Lime Green 257

15
YEAR
WARRANTY



A3GRY-3MON1
Monument 8026



B3GRY-3MER1
Merino 918



B4GRY-4YEL1
Yellow 18



C4GRY-2MAG2
Magenta 526



C4GRY-1DBE4
Dark Blue 326



C7GRY-7TEA1
Teal 338



OL1800
Yellow 18

A4GRY-4TEA1 Single door, 4 hinge W 380mm x D 450mm x H880mm

A4GRY-2PUR2 Two door, 4 hinge W 380mm x D 450mm x H880mm

A4GRY-1ORA4 Four door, 4 hinge W 380mm x D 450mm x H880mm

A3GRY-3MON1 Single door, 3 hinge W 380mm x D 450mm x H670mm

B3GRY-3MER1 Deep body, Single door, 3 hinge W 380mm x D 585mm x H670mm

B4GRY-4YEL1 Deep body, Single door, 4 hinge W 380mm x D 585mm x H880mm

B4GRY-2MBE2 Deep body, Two door, 4 hinge W 380mm x D 585mm x H880mm

C4GRY-4LGN1 Wide body, Single door, 4 hinge W 490mm x D 485mm x H880mm

C4GRY-2MAG2 Wide body, Two door, 4 hinge W 490mm x D 485mm x H880mm

C4GRY-1DBE4 Wide body, Four door, 4 hinge W 490mm x D 485mm x H880mm

C7GRY-7TEA1 Wide body, Long door, 7 hinge W 490mm x D 485mm x H1510mm

OL1800. Single door unit. Supplied with hood, base, shelf and hanging rail. Features a 3 way locking system. W 370mm x D 500mm x H2000mm

FSP COOL LOCKERS® Lockers are different...

FSP COOL LOCKERS® Plastic Lockers have unique advantages over lockers made from traditional materials such as timber and metal. Here are just a few of them:

- ▶ UV stable with a HUGE range of anti-fade colours to choose from
- ▶ Lightweight & Stackable so they are easy to move and install
- ▶ The lockers are made of Heavy Duty Polyethylene with high-grade stainless steel door plate and hinge - so they are perfect for wet areas, coastal locations and outdoors
- ▶ Quieter than metal or timber lockers, no banging doors.
- ▶ Graffiti is easier to remove - No painting required
- ▶ Easy to clean and lowest maintenance. Just hose them out!
- ▶ Proven strength and durability - backed by our 15 year warranty.



US Patent No. 9113704 European Patent No. 12820162.1

US Patent No. 9113704 European Patent No. 12820162.1

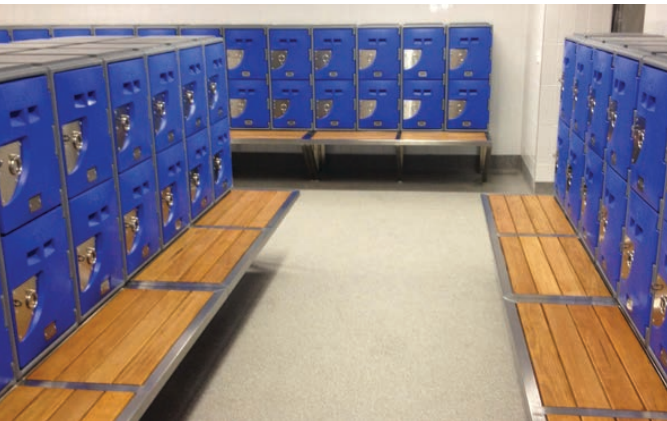

US Patent No. 9113704 European Patent No. 12820162.1

US Patent No. 9113704 European Patent No. 12820162.1

Build your lockers....your way.

The FSP COOL LOCKERS® system is based on a simple modular system that allows you incredible flexibility. Choose different body footprints. Choose different sized doors and door colours in the same locker bank or within a single locker body.

You can create your own unique locker installation in three simple steps:

1 Choose Locker Body
Select from 5 different locker "footprint" sizes - A series, B series (deepest unit), C series (widest unit), D series (narrowest unit), and the E series. All are available in 1-9 hinges.

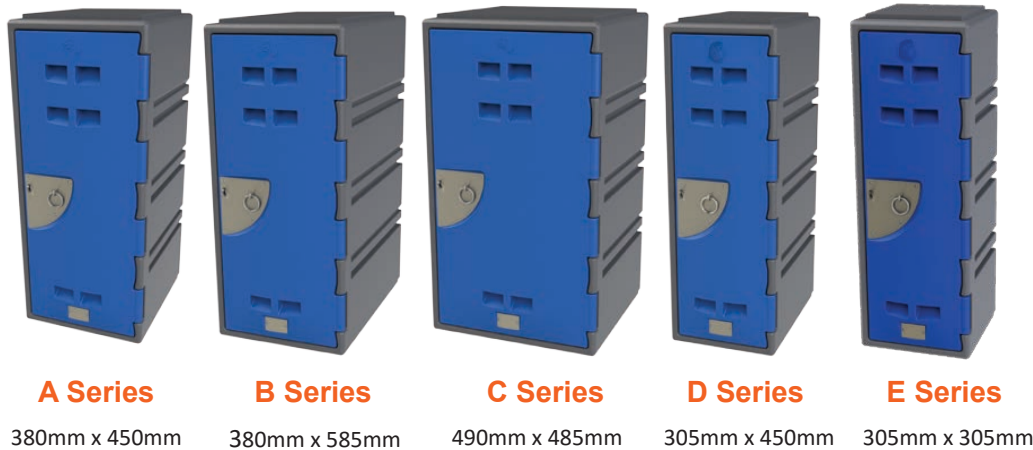

Suits the small door. Avail. 1-9 hinge	Same width as A but deeper body. Avail. 1-9 hinge	Wider body for wider door. Avail. 1-9 hinge	Narrowest body. Avail. 1-9 hinge	Same width as D but shallower body. Avail. 1-9 hinge
--	---	---	----------------------------------	--

US Patent No. 9113704 European Patent No. 12820162.1

2 Choose Locker Height
Choose from 1 - 9 hinge heights. You can select how many separate lockers you want to have in a single body. Every locker body size comes in 1 to 9 hinge options.



3 Choose Locker Door(s)
Select your locker door sizes and colours. Choose any combination of different sized doors to fill the selected locker in any of your chosen colours. The creative possibilities are endless.



US Patent No. 9113704 European Patent No. 12820162.1

The A series is a 380mm wide x 450mm deep locker body available in 1 - 9 hinges (A1 - A9). From 1 - 9 hinge doors can be installed, with combinations of different sized doors on the same locker body being possible.

► **HUGE COLOUR RANGE**

A4GRY-4SBE1



Stock Blue

A1GRY-1DBE1



Dark Blue 326

A2GRY-2YEL1



Yellow 18

A3GRY-3MON1



Monument 8026

A4GRY-4SBE1 A Body, 4 Hinge Height - Single Door, (available in 1-4 door variations)

W 380mm x D 450mm x H880mm

A1GRY-1DBE1 A Body, 1 Hinge Height - Single Door W 380mm x D 450mm x H250mm

A2GRY-2YEL1 A Body, 2 Hinge Height - Single Door, (also available in 2 x 1 Hinge Doors) W 380mm x D 450mm x H465mm

A3GRY-3MON1 A Body, 3 Hinge Height - Single Door, (available in 1-3 door variations) W 380mm x D 450mm x H670mm

US Patent No. 9113704 European Patent No. 12820162.1

A5GRY-2ORA2-1ORA1



Orange 61

A9GRY-3MAG3

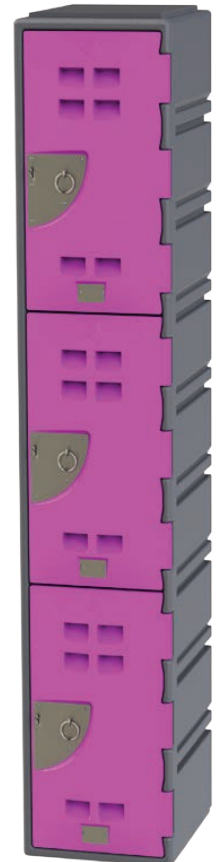

Magenta 526

A8GRY-8SBE1

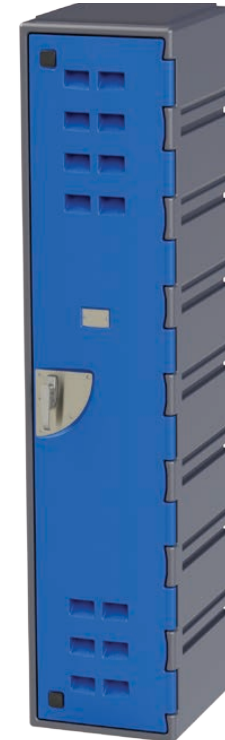

Stock Blue

A7GRY-1YEL7



Yellow 18

A6GRY-3LBE2



Light Blue 325

► **DOOR VARIATIONS - From 1 to 9 doors**

A5GRY-2ORA2-1ORA1 A Body, 5 Hinge Height - Multi-size doors, (available in 1-5 door variations) W 380mm x D 450mm x H1090mm

A6GRY-3LBE2 A Body, 6 Hinge Height - Two Door, (available in 1-6 door variations) W 380mm x D 450mm x H1300mm

A7GRY-1YEL7 A Body, 7 Hinge Height - 7 Door, (available in 1-7 door variations) W 380mm x D 450mm x H1510mm

A8GRY-8SBE1 A Body, 8 Hinge Height - Single Door, (available in 1-8 door variations) W 380mm x D 450mm x H1720mm

A9GRY-3MAG3 A Body, 9 Hinge Height - 3 Door, (available in 1-9 door variations) W 380mm x D 450mm x H1930mm

US Patent No. 9113704 European Patent No. 12820162.1

The B series is the deepest locker body at 380mm wide x 585mm deep, available in 1 - 9 hinges (B1 - B9). From 1 - 9 hinge doors can be installed, with combinations of different sized doors on the same locker body being possible.

▶ **HUGE COLOUR RANGE**

B4GRY-4YEL1



Yellow 18

B4GRY-4YEL1 B Body, 4 Hinge Height - Single Door, (available in 1-4 door variations) W 380mm x D 585mm x H880mm

B1GRY-1TEA1 B Body, 1 Hinge Height - Single Door

W 380mm x D 585mm x H250mm

B2GRY-2DGY1 B Body, 2 Hinge Height - Single Door, (also available in 2 x 1 Hinge Doors) W 380mm x D 585mm x H465mm

B3GRY-3PUR1. B Body, 3 Hinge Height - Single Door, (available in 1-3 door variations) W 380mm x D 585mm x H670mm

B1GRY-1TEA1



Teal 338

B2GRY-2DGY1



Dark Grey 816

B3GRY-3PUR1



Purple 538

US Patent No. 9113704 European Patent No. 12820162.1

B5GRY-4SGN1-1SGN1



Stock Green 209

B6GRY-4HRD1-1HRD2



Heritage Red 45

B7GRY-4TEA1-3TEA1



Teal 338

B8GRY-8SBE1



Stock Blue

B9GRY-9ORA1



Orange 61

▶ **DOOR VARIATIONS - From 1 to 9 doors**

B5GRY-4SGN1-1SGN1 B Body, 5 Hinge Height - Multi-size doors, (available in 1-5 door variations) W 380mm x D 585mm x H1090mm

B6GRY-4HRD1-1HRD2 B Body, 6 Hinge Height - Multi-size doors, (available in 1-6 door variations) W 380mm x D 585mm x H1300mm

B7GRY-4TEA1-3TEA1 B Body, 7 Hinge Height - Multi-size doors, (available in 1-7 door variations) W 380mm x D 585mm x H1510mm

B8GRY-8SBE1 B Body, 8 Hinge Height - Single Door, (available in 1-8 door variations) W 380mm x D 585mm x H1720mm

B9GRY-9ORA1 B Body, 9 Hinge Height - Single Door, (available in 1-9 door variations) W 380mm x D 585mm x H1930mm

US Patent No. 9113704 European Patent No. 12820162.1

The C series is the widest locker body at 490mm wide x 485mm deep, available in 1 - 9 hinges (C1 - C9). From 1 - 9 hinge doors can be installed, with combinations of different sized doors on the same locker body being possible.

► **HUGE COLOUR RANGE**

C1GRY-1RED1



Red 551

C1GRY-1HRD1. C Body, 1 Hinge Height - Single Door W 490mm x D 485mm x H250mm

C2GRY-2PUR1. C Body, 2 Hinge Height - Single Door, (also available in 2 x 1 Hinge Doors) W 490mm x D 485mm x H465mm

C3GRY-3ORA1. C Body, 3 Hinge Height - Single Door, (available in 1-3 door variations)

W 490mm x D 485mm x H670mm

C4GRY-4LGN1. C Body, 4 Hinge Height - Single Door, (available in 1-4 door variations)

W 490mm x D 485mm x H880mm

US Patent No. 9113704 European Patent No. 12820162.1

C2GRY-2PUR1



Purple 538

C3GRY-3ORA1



Orange 61

C4GRY-4LGN1



Lime Green 257

C5GRY-1RED2-3RED1



Red 551

C6GRY-1HRD6



Heritage Red 45

C7GRY-1SGN7



Stock Green 209

C8GRY-8DBE1

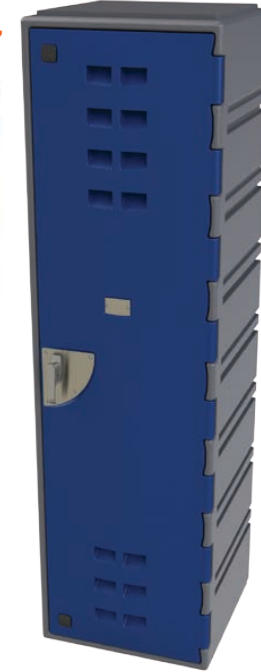

Dark Blue 326

C9GRY-3YEL3



Yellow 18

► **DOOR VARIATIONS - From 1 to 9 doors**

C5GRY-1RED2-3RED1 C Body, 5 Hinge Height - Multi-size doors, (available in 1-5 door variations) W 490mm x D 485mm x H1090mm

C6GRY-1HRD6 C Body, 6 Hinge Height - 6 Door, (available in 1-6 door variations) W 490mm x D 485mm x H1300mm

C7GRY-1SGN7 C Body, 7 Hinge Height - 7 Door, (available in 1-7 door variations) W 490mm x D 485mm x H1510mm

C8GRY-8DBE1 C Body, 8 Hinge Height - Single Door, (available in 1-8 door variations) W 490mm x D 485mm x H1720mm

C9GRY-3YEL3 C Body, 9 Hinge Height - 3 Door, (available in 1-9 door variations) W 490mm x D 485mm x H1930mm

US Patent No. 9113704 European Patent No. 12820162.1

The D series is the narrowest locker body at 305mm wide x 450mm deep, available in 1 - 9 hinges (D1 - D9). From 1 - 9 hinge doors can be installed, with combinations of different sized doors on the same locker body being possible.

► **HUGE COLOUR RANGE**

D2GRY-2YEL1



Yellow 18

D2GRY-2YEL1 D Body, 2 Hinge Height - Single Door, (also available in 2 x 1 Hinge Doors) W 305mm x D 450mm x H465mm

D1GRY-1ORA1 D Body, 1 Hinge Height - Single Door W 305mm x D 450mm x H250mm

D3GRY-2RED1 D Body, 3 Hinge Height - Single Door, (available in 1-3 door variations) W 305mm x D 450mm x H670mm

D4GRY-4MON1 D Body, 4 Hinge Height - Single Door, (available in 1-4 door variations) W 305mm x D 450mm x H880mm

D1GRY-1ORA1



Orange 61

D3GRY-2RED1



Red 551

D4GRY-4MON1



Monument 8026

US Patent No. 9113704 European Patent No. 12820162.1

D5GRY-3LBE1-2LBE1



Light Blue 325

D7GRY-1SGN1-2SGN3



Stock Green 209

D6GRY-1PUR6



Purple 538

D8GRY-8DBE1



Dark Blue 326

D9GRY-3WHE3



Wheat 930

► **DOOR VARIATIONS - From 1 to 9 doors**

D5GRY-3LBE1-2LBE1 D Body, 5 Hinge Height - Multi-size doors, (available in 1-5 door variations) W 305mm x D 450mm x H1090mm

D6GRY-1PUR6 D Body, 6 Hinge Height - 6 Door, (available in 1-6 door variations) W 305mm x D 450mm x H1300mm

D7GRY-1SGN1-2SGN3 D Body, 7 Hinge Height - Multi-size doors, (available in 1-7 door variations) W 305mm x D 450mm x H1510mm

D8GRY-8DBE1 D Body, 8 Hinge Height - Single Door, (available in 1-8 door variations) W 305mm x D 450mm x H1720mm

D9GRY-3WHE3 D Body, 9 Hinge Height - 3 Door, (available in 1-9 door variations) W 305mm x D 450mm x H1930mm

US Patent No. 9113704 European Patent No. 12820162.1

The E series is the shallowest locker body at 305mm wide x 305mm deep, available in 1 - 9 hinges (E1 - E9). From 1 - 9 hinge doors can be installed, with combinations of different sized doors on the same locker body being possible.

▶ **HUGE COLOUR RANGE**

E3GRY-3SGN1



Stock Green 209



E3GRY-3SGN1 E Body, 3 Hinge Height - Single Door, (available in 1-3 door variations) W 305mm x D 305mm x H670mm

E1GRY-1PUR1 E Body, 1 Hinge Height - Single Door W 305mm x D 305mm x H250mm

E2GRY-2WHE1 E Body, 2 Hinge Height - Single Door, (also available in 2 x 1 Hinge Doors) W 305mm x D 305mm x H465mm

E4GRY-4SBE1 E Body, 4 Hinge Height - Single Door, (available in 1-4 door variations) W 305mm x D 305mm x H880mm

E1GRY-1PUR1



Purple 538

E2GRY-2WHE1



Wheat 930

E4GRY-4SBE1



Stock Blue

US Patent No. 9113704 European Patent No. 12820162.1

E5GRY-3RED1-1RED2



Red 551

E7GRY-1ORA4-3ORA1

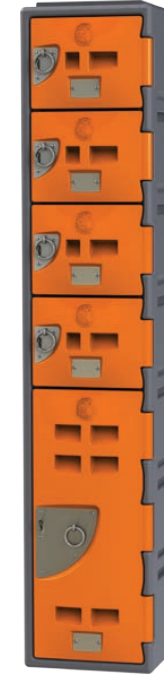

Orange 61

E6GRY-2YEL1-4YEL1



Yellow 18

E8GRY-8DBE1

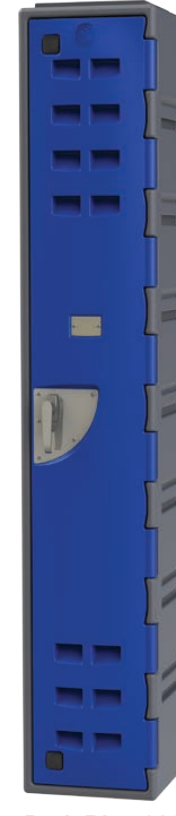

Dark Blue 326

E9GRY-9LGN1

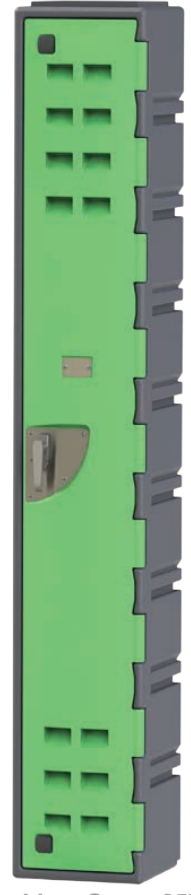

Lime Green 257

▶ **DOOR VARIATIONS - From 1 to 9 doors**

E5GRY-3RED1-1RED2 E Body, 5 Hinge Height - Multi-size doors, (available in 1-5 door variations) W 305mm x D 305mm x H1090mm

E6GRY-2YEL1-4YEL1 E Body, 6 Hinge Height - Multi-size doors, (available in 1-6 door variations) W 305mm x D 305mm x H1300mm

E7GRY-1ORA4-3ORA1 E Body, 7 Hinge Height - Multi-size doors, (available in 1-7 door variations) W 305mm x D 305mm x H1510mm

E8GRY-8DBE1 E Body, 8 Hinge Height - Single Door, (available in 1-8 door variations) W 305mm x D 305mm x H1720mm

E9GRY-9LGN1 E Body, 9 Hinge Height - Single Door, (available in 1-9 door variations) W 305mm x D 305mm x H1930mm

US Patent No. 9113704 European Patent No. 12820162.1

There's FSP COOL LOCKERS® in the colour you want.

FSP COOL LOCKERS® Plastic Lockers come in a fantastic range of bright modern colours. You can have FSP COOL LOCKERS® Plastic Lockers in your corporate livery colours, your teams colours, your school colours or just your favourite colours.

FSP can also permanently print your logo onto your lockers. The printing technique used has been developed to endure for the lifetime of your lockers. It is completely resistant to the elements and most chemicals.



Black 70
BLK



Dark Blue 326
DBE



Dark Grey 816
DGY



Grey FSP
GRY



Heritage Green FSP
HGN



Heritage Red 45
HRD



Light Blue 325
LBE



Lime Green
257
LGN



Light Grey 817
LGY



Magenta 526
MAG



Mountain Blue 392
MBE



Merino 918
MER



Mist Green 206
MGN



Monument 8026
MON



Orange 61
ORA



Purple 538
PUR



Red 551
RED



Rivergum 234
RIV



Stock Blue
SBE



Stock Green 209
SGN



Slate Grey 89
SGY



Teal 338
TEA

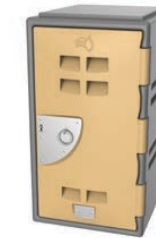

Wheat 930
WHE



White 05
WHI



Yellow 18
YEL

Printed colours shown above are indicative only and may not accurately represent actual colours.

Printed colours shown above are indicative only and may not accurately represent actual colours.

US Patent No. 9113704 European Patent No. 12820162.1

US Patent No. 9113704 European Patent No. 12820162.1

FSP COOL LOCKERS® have all the accessories you need. We can supply extra shelves, stainless steel number plates, sloping tops, kick bases, and combination padlocks. Coin operated units are also available.

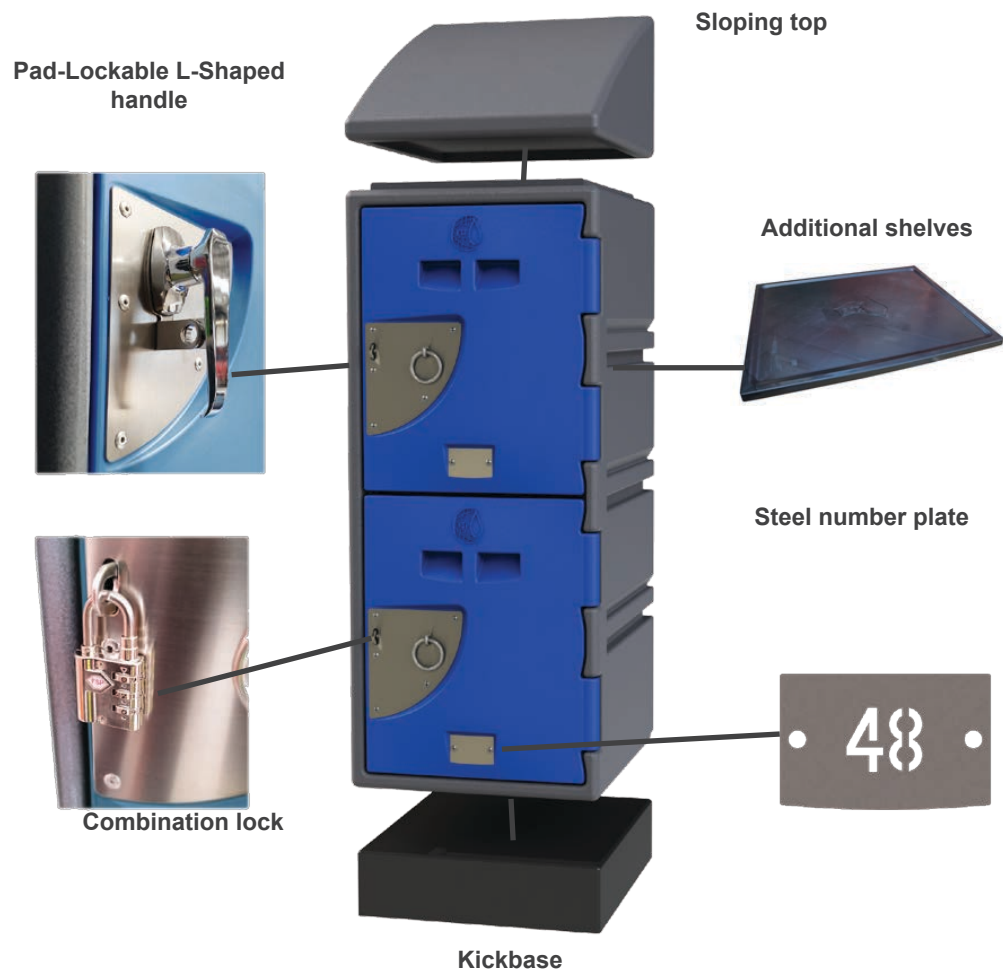

Lockers minimise damage to school from vandals



Schools installing FSP COOL LOCKERS® Plastic Lockers have many reasons to be confident that they have one of the most vandal resistant lockers available today.

However, one school had reason to be especially happy with their choice. When a vandal deliberately started a fire inside one of their lockers, it could have led to major damage to their school building. The school's superintendent was very impressed with the minimal melting and damage.

FSP received a letter of recommendation from the principal of the school to vouch for the impressive fire retardant qualities of FSP Lockers. With vandalism a problem in many schools, FSP COOL LOCKERS® Plastic Lockers have proven to be a safer choice than older-style lockers.

Product codes for ordering accessories:

Pad-Lockable L-Shaped handle: HCLHPLC

Combination lock: OLCL

Kickbase: OLBASEa, OLBASEb, OLBASEc, OLBASEd, OLBASEe*

Steel number plate: OLNUMBERS

Additional shelves: OLSHELFa, OLSHELFb, OLSHELFc, OLSHELFd, OLSHELFe*

Sloping top: OLTOPa, OLTOPb, OLTOPc, OLTOPd, OLTOPe* (available in 25 different colours)

* a, b, c, d, e depending on locker series.

US Patent No. 9113704 European Patent No. 12820162.1

US Patent No. 9113704 European Patent No. 12820162.1

Select body size

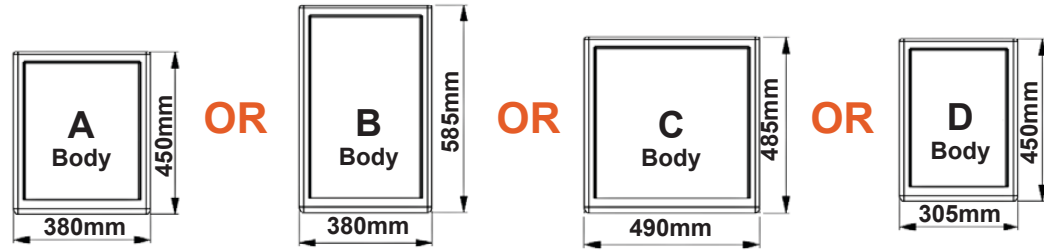

There are five body sizes and three door widths. The lines in the diagram represent the possible combinations of the locker bodies and doors from 1 to 9 hinges.

Select heights

Select the height of the locker bodies that you want for your locker bank.

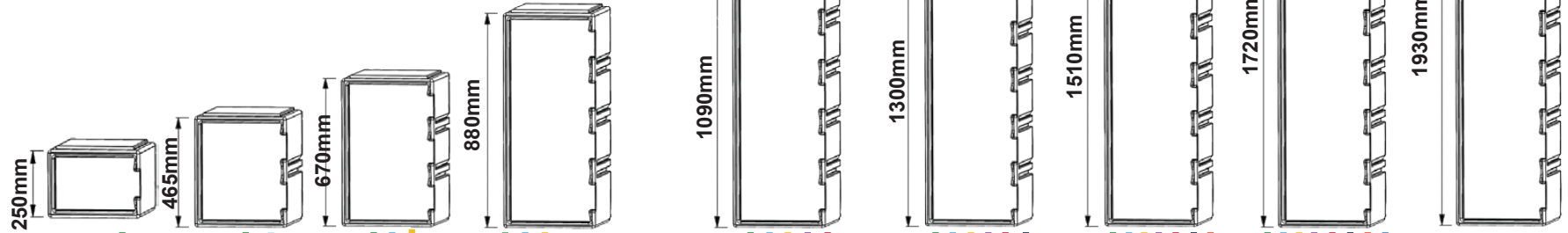

Select door options

You can mix and match doors with different heights in the same locker body to create lockers with different storage capacities in the same bank of lockers.

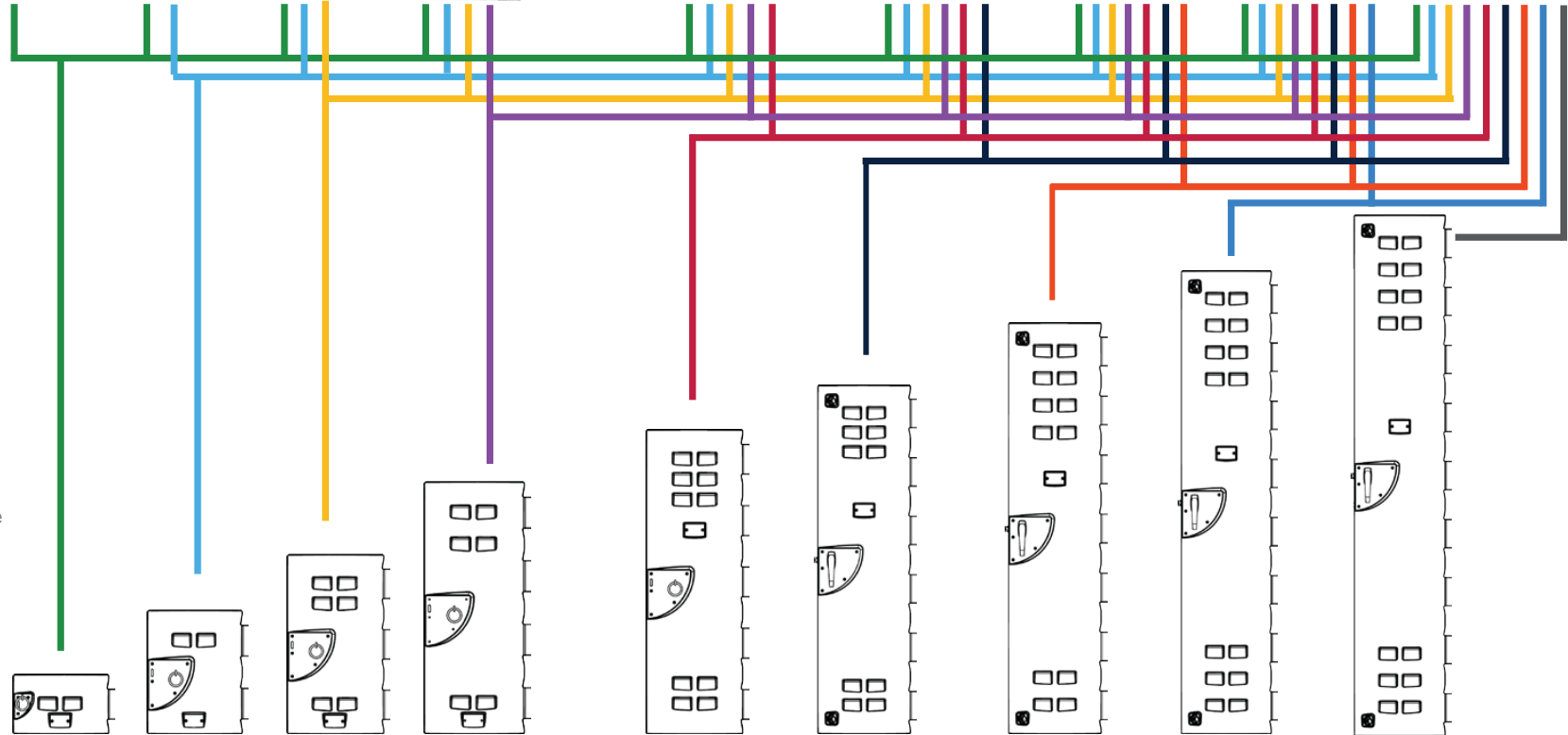

US Patent No. 9113704 European Patent No. 12820162.1

US Patent No. 9113704 European Patent No. 12820162.1

Mobile Phone Locker



The perfect storage unit for mobile phones, wallets and other small personal items. The FSP Mobile Phone Locker is designed to fit most modern mobile phones including larger smartphones.

Resistant to most cleaning solvents. Graffiti, chewing gum or stickers can be removed without affecting the integrity of the enclosure.

Resists being cut or jimmied open. Fitted with stainless steel locker loop. Designed to be secured closed with an appropriate padlock for maximum security. Optional padlock available.

W 180mm x D 240mm
x H600mm

Easily mountable locker banks.

Available in a range of colours to suit your environment. Optional wedge-top hood and kicker base. Optional USB charging ports.

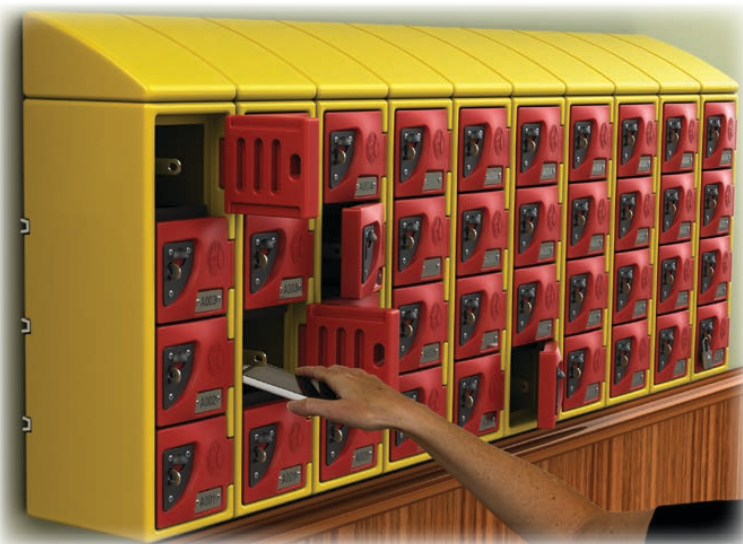

US Patent No. 9113704 European Patent No. 12820162.1



Vented Wardrobe Locker

Constructed from polyethylene Will not dent or rust. Resists knocks and bumps. No hinges to jam. No moving parts to maintain.

Resistant to most cleaning solvents. Graffiti, chewing gum or stickers can be removed without affecting the integrity of the enclosure.

Available in a range of colours to suit your environment.



Resists being cut or jimmied open. Fitted with 3-way locking mechanism. Designed to be secured closed with an appropriate padlock for maximum security. Optional padlocks available.

Width: 730mm
Depth: 550mm
Height: 1937mm
(2237mm with top and base)

US Patent No. 9113704 European Patent No. 12820162.1

OL1800 Locker



Constructed from polyethylene
Will not dent or rust. Resists
knocks and bumps. No hinges to
jam. No moving parts to maintain.

Resistant to most cleaning solvents.
Graffiti, chewing gum or stickers can be
removed without affecting the integrity
of the enclosure.

Single door unit. Supplied with hood,
base, shelf and hanging rail. Features
a 3 way locking system. Resists being
cut or jimmed open. Optional padlocks
available.

Width: 370mm
Depth: 500mm
Height: 2000mm



Available in a range of colours to suit
your environment.

How To Order

For more information regarding our FSP COOL LOCKERS® systems or to
view samples of our lockers, please Tel.: +32-56-65-31-74 or visit us online at:
www.coollockers.eu

FSP COOL LOCKERS® EUROPE
Sprietestraat 210
8792 Desselgem
fsp@coollockers.eu

US Patent No. 9113704 European Patent No. 12820162.1



Sender Address
FSP COOL LOCKERS® EUROPE
Sprietestraat 210
8792 Desselgem
Belgium

Tel: +32-56-65-31-74

